

# pamar

## PC 2035 I

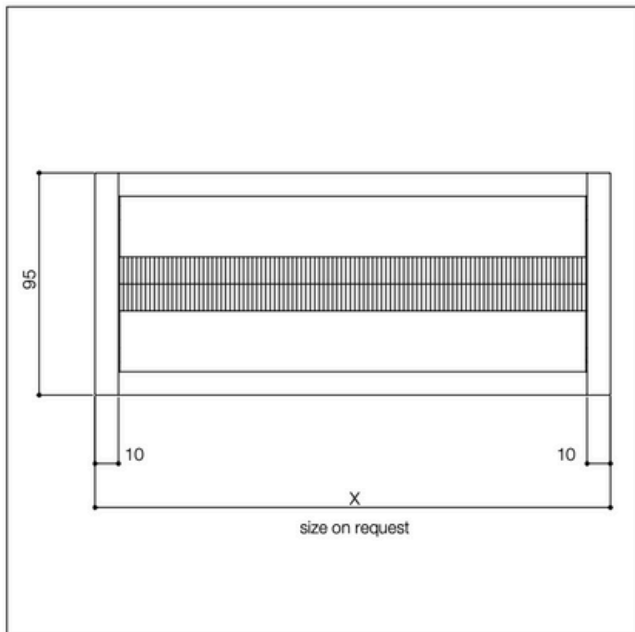

vista frontale **frontal view**

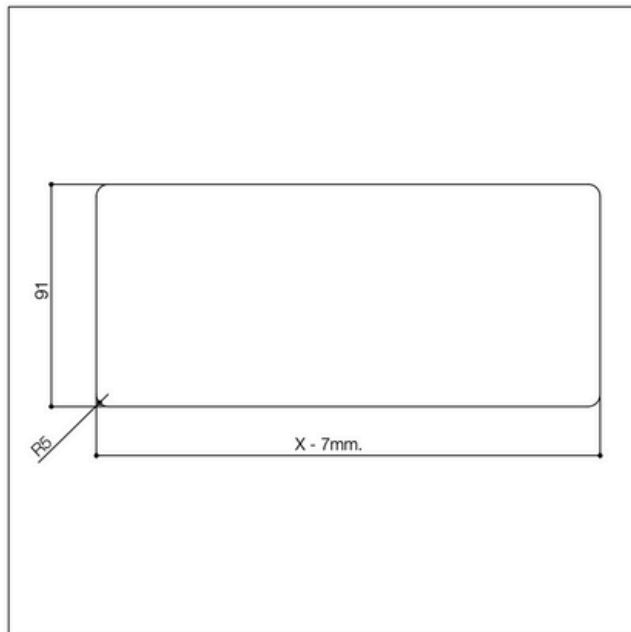

dima foro **hole template**

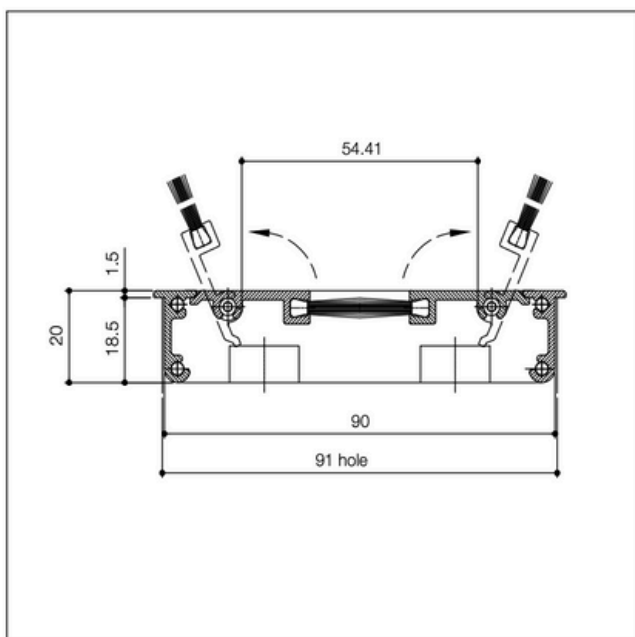

sezione **section**

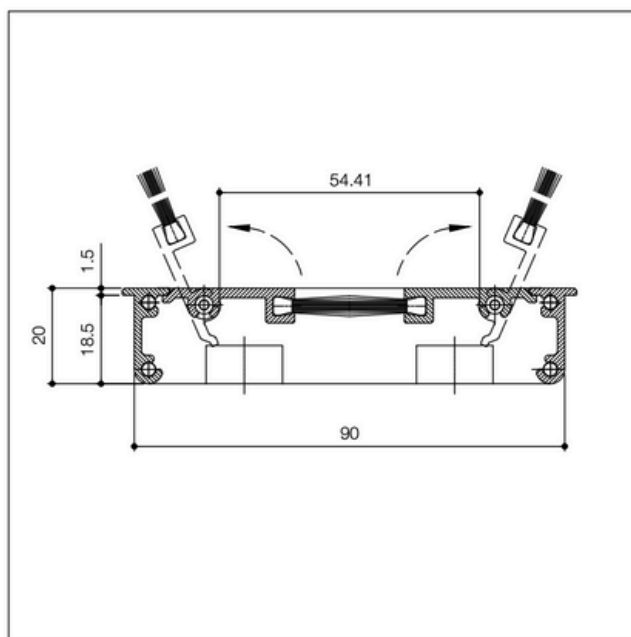

sezione incassato aperto **embedded section open**