

# pamar

## MN 685 Z

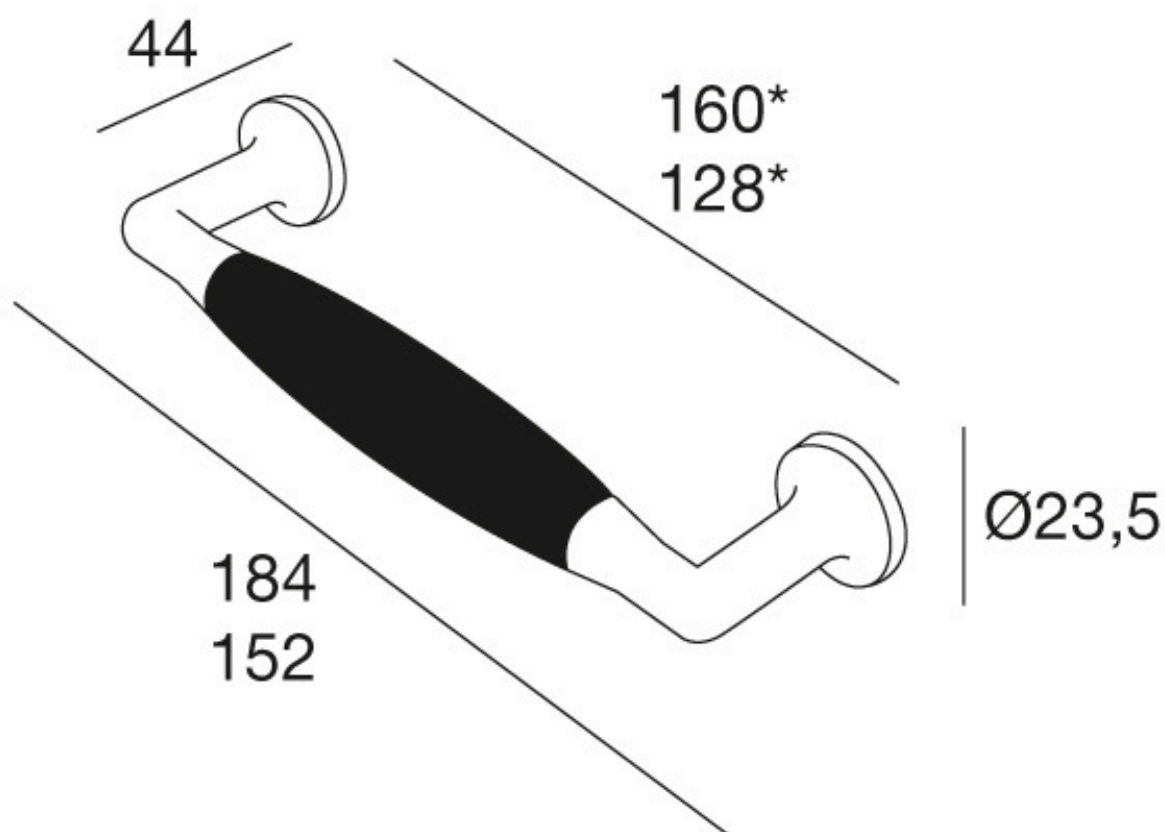

---

Pamar S.r.l.  
Via Sirtori 41, 20838  
Renate (MB), Italy

*International patents have been deposited for Pamar models.  
Imitations will be punished by law.*