

pamar

MN 868 Z

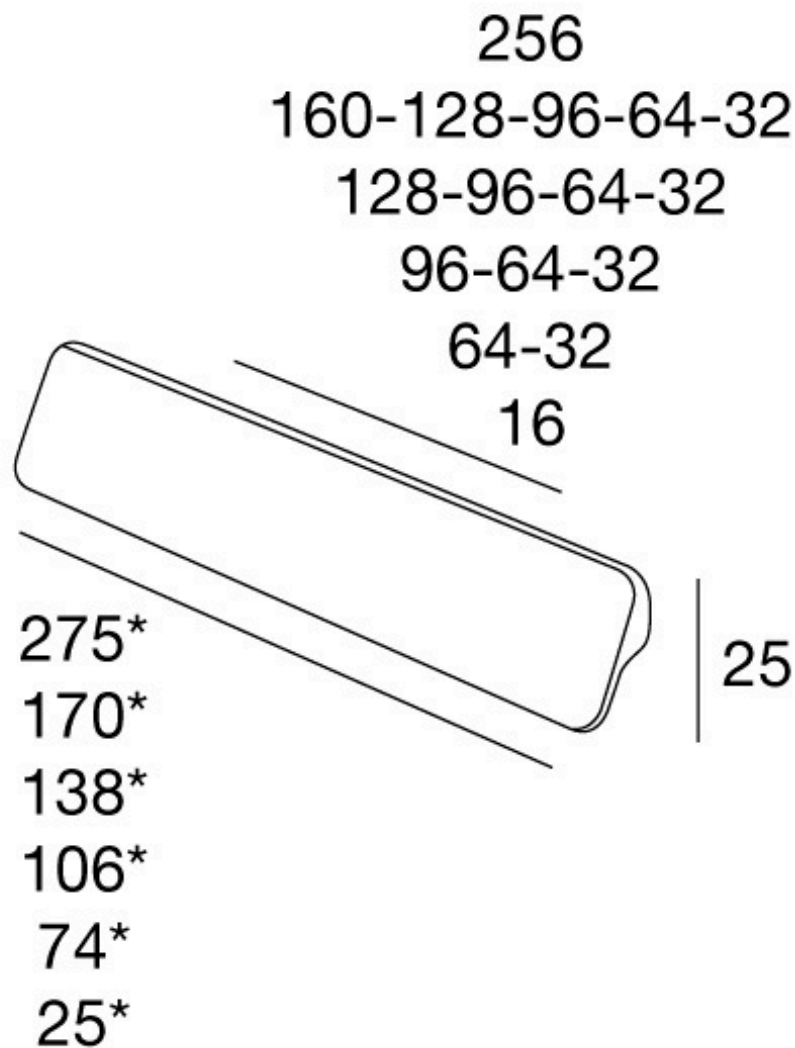

interasse multiplo / multiple Inter-axial